

CM14 Next Gen.

OPERATION & MAINTENANCE MANUAL

AUS|NZ

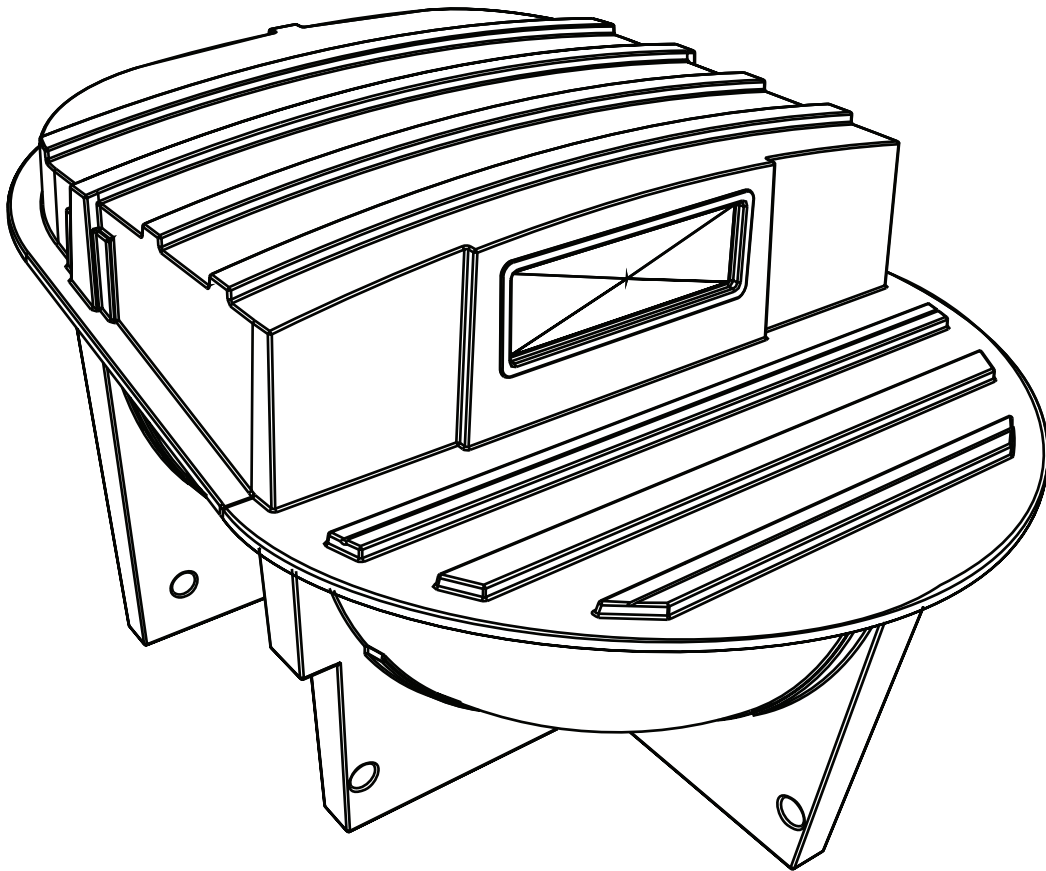

OMCM-14-2023-12-05

TABLE OF CONTENTS

SAFETY CONSIDERATIONS	1
QUICK SERVICE GUIDE	2
STARTER-BED OF ORGANIC MATTER	3
CHOOSING A BULKING AGENT?	3
OPERATING PROCEDURE	4
HOW OFTEN TO ADD BULKING MATERIAL	5
HOW TO CLEAN	5
PUBLIC HEALTH CONSIDERATIONS	5
IN CASE OF INSECTS	6
TROUBLESHOOTING	7

SAFETY CONSIDERATIONS

TO BE WORN AT ALL TIMES WHEN SERVICING THE TOILET AND COMPOST CHAMBER.

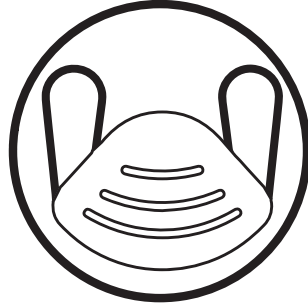

DUST RESPIRATOR

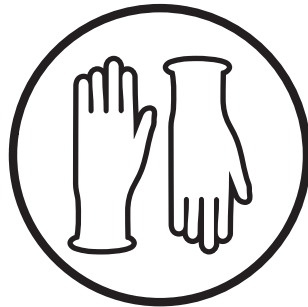

GLOVES

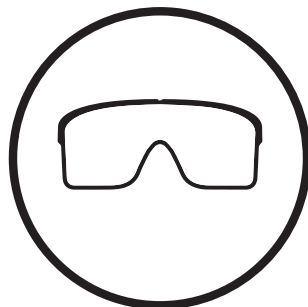

GLASSES

QUICK SERVICE GUIDE

DAILY OR WEEKLY:



Clean fixtures using bio-compatible cleaners



Flush urinal piping using bacterial based cleaner or hot water (for urine diverting pedestal)



Add bulking agent via pedestal

FOR DOMESTIC USE	
After each use	½ x Cup
FOR COMMERCIAL USE	
Option 1: Weekly	1 x Household Bucket/Pedestal
Option 2: Twice Weekly	½ x Household Bucket/Pedestal

MONTHLY:

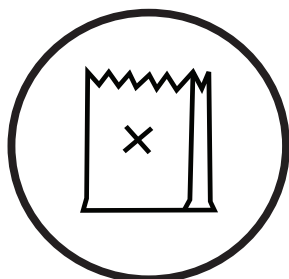

Add compost enhancing bacteria

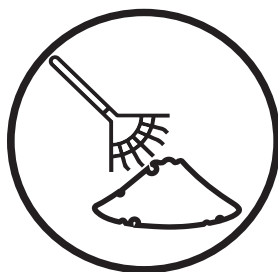

Level pile and add bulking agent when cone is 40cm high

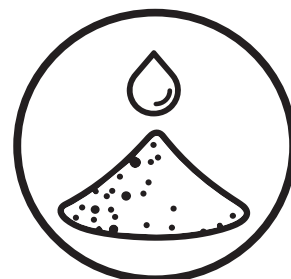

Check pile is moist and crumbly not sodden or dry

ANNUALLY:

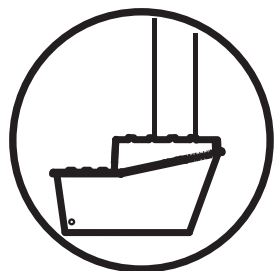

Clear vent system and remove obstructions

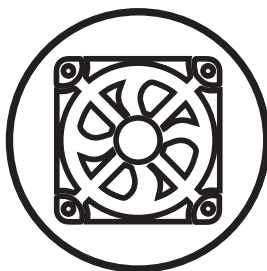

Clean fan and ensure correct function



Clean drain line and flush with clean hot water



Remove compost if necessary

STARTER-BED OF ORGANIC MATTER

SUITABLE BULKING MATERIAL



Hemp



Dry Leaves



Peanut or coconut
husk

NOT SUITABLE BULKING MATERIAL

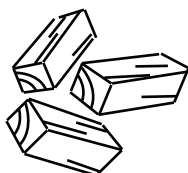

Large wood chips

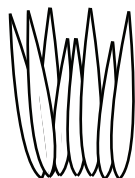

Lawn clippings



Fine sawdust

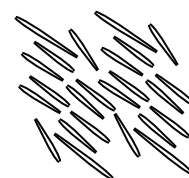

Sugar cane mulch

CHOOSING A BULKING AGENT?

Ecoflo recommends the use of wood shavings in your Clivus Multrum system, however if this is difficult to source in your area we recommend any of the following bulking agents with these characteristics:

- Dry but readily absorbs moisture
- Has high carbon content greater than 35%
- Does not form a ball or mat when wet
- Traps air and is known to compost well
- Contains no chemical contaminants to affect compost bacteria

OPERATING PROCEDURE

- 1 This procedure should be followed whenever the tank is completely empty. Add bulking agent into the bottom of the tank spread evenly. Material must come up 50mm behind the bottom edge of the baffle to create a seal between compartments.

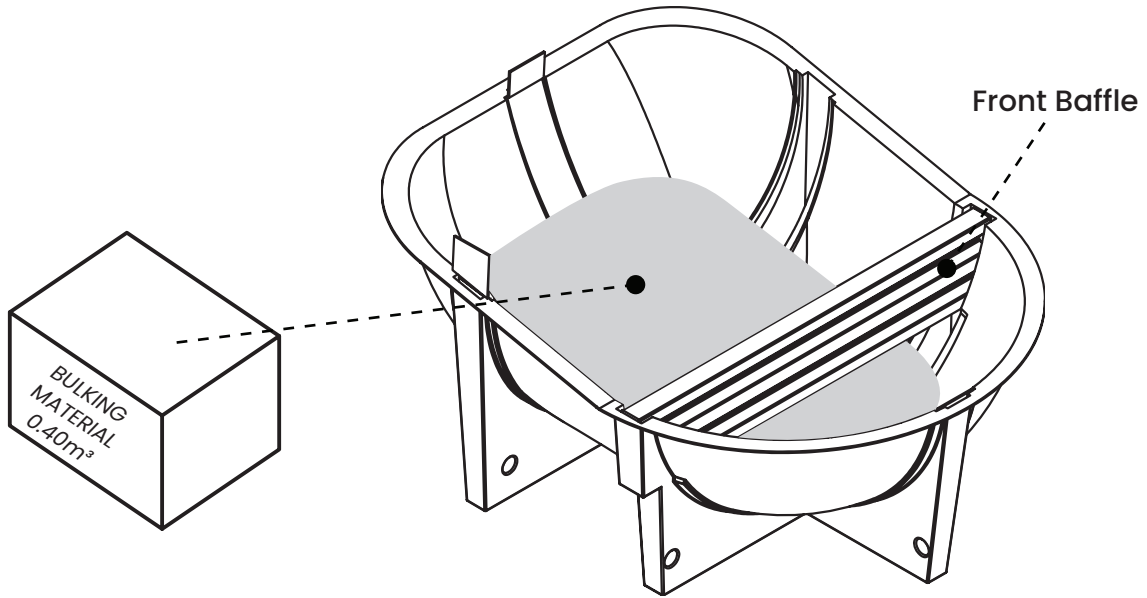

- 2 Dampen the wood shavings with water. This process breaks down the surface tension and allows the bulking agent to begin absorbing the urine as it enters the tank.

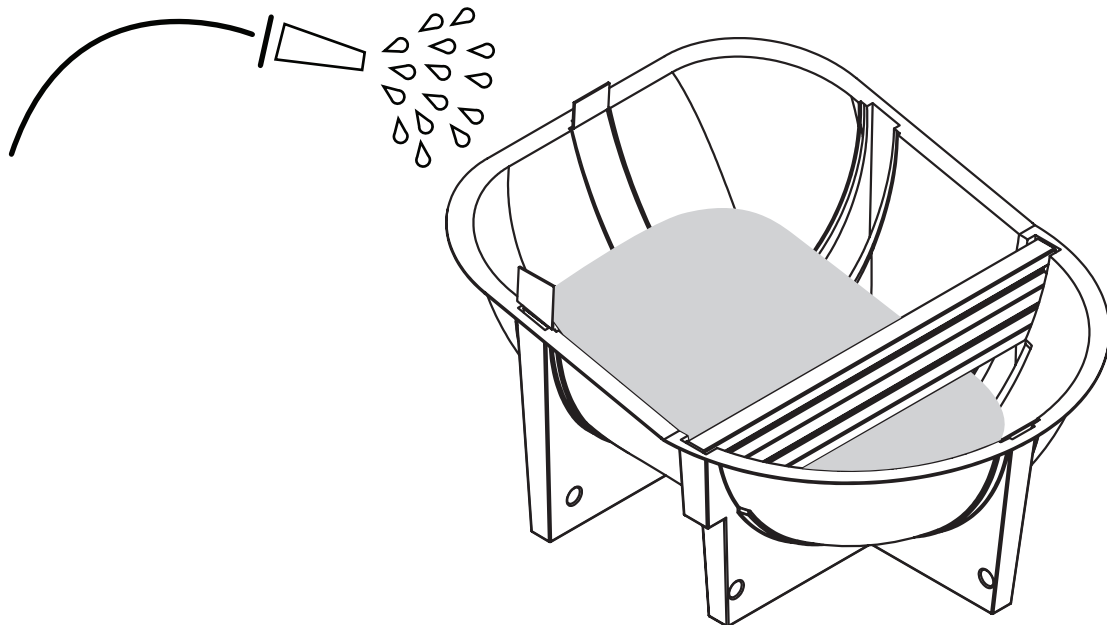

- 3 After normal use for 14 days, starter bacteria can be added. Refer to starter bacteria instructions on packet. Alternative source of bacteria could be to add several buckets full of well composted garden material or commercial compost humus mixed into the top pile.

HOW OFTEN TO ADD BULKING MATERIAL

FOR DOMESTIC OR RESIDENTIAL INSTALLATIONS:

It is recommended to have a small bucket of wood shavings next to the toilet. Apply a handful of your chosen bulking material after each use.

FREQUENCY	AMOUNT
After each use	½ x Cup

FOR COMMERCIAL AND PUBLIC INSTALLATIONS:

The facility should be professionally cleaned at least weekly or twice weekly. When cleaning, bulking agent should be added down the chute.

FREQUENCY	AMOUNT
Weekly	1 x Household Bucket
Twice Weekly	½ x Household Bucket

HOW TO CLEAN

DO

- Clean inside of pedestal using small amount of water and biodegradable cleaner.

AVOID

- Harsh disinfectants (eg. bleach, caustic, chlorine, etc.)
- Chemical toilet waste
- Items such as disposable nappies and hygiene products
- Food waste
- Anything that is inorganic or non-biodegradable

PUBLIC HEALTH CONSIDERATIONS

USE OF END PRODUCT

- The health department requires the end product to be buried under no less than 100mm of top soil, this should be away from where children play.
- Refer to council regulations for further information in your local area around disposal sites.
- It is not recommended to use the finished compost on root vegetables.

IN CASE OF INSECTS

- Insects often appear due to the fan being off for extended periods of time and enter usually through the exit vent. To avoid check to see if the vent fan is functioning.
- Check to see that the top inspection door and bottom access door are on the composting tank are sealing correctly and not left open.
- Power off the fan and spray a pyrethum based insect spray into the pile and let sit for 30 minutes before turning the fan on again. Repeat this step daily over the next week.
- Vinegar flies are usually only active for the first 6 months of a compost tank and this is usually a signal that the compost is too acidic or the starter bacteria is still yet to break down. Check to see if the bulking material being used is recommended as a suitable bulking material in the front of this manual.
- If there is still acidic odor apply a generous amount of garden lime to the pile and rake according. This is to be used as a one time solution only (can be sourced from local nurseries). This should help reset the PH balance of the compost.

More information on dealing with vinegar flies can be found under our Troubleshooting section on our website.

MAINTENANCE SCHEDULE

COMPOST PILE

- Inspect the compost chamber for any foreign objects.
- If the pile is forming a cone shape 40-50cm in height, this should be leveled.
- The consistency of the compost should be porous and crumbly with no large clumps.
- The pile should appear moist but not sodden.
- If too wet apply more bulking agent.
- If too dry apply a light spray of water to the pile.
- Add more composting bacteria during periods of high usage.

VENT SYSTEM

- Ensure the vent system is clear of debris and obstruction (cobwebs).
- A slight draft should be felt on the back of a wet hand over the pedestal to ensure proper function of the vent system.

LIQUID DRAIN (NOT INCLUDING PUMP SYSTEMS)

- Ensure this is free of obstructions any more than 3–4cm of liquid buildup in the chamber is cause for concern, refer to troubleshooting guide.

REMOVING FINISHED COMPOST

- It is not required to remove compost until the leveled waste has reached the bottom of the inspection door. Remove a wheelbarrow full of compost and leave material up to the underside of the baffle.

TROUBLESHOOTING

ODOUR IS PRESENT IN THE TOILET ROOM

A properly functioning Clivus Multrum system should not produce odors in the toilet room.

- Check that the power source is connected and voltage is set to 12V and power point is switched on.
- Check that fan vent is operating correctly and that the vent pipe is free of blockages or dense cobwebs.
- Ensure the fan has been installed so the draw of the fan is upward into the vent and not blowing downwards into the compost pile.
- Check that open windows and doors are not 'sucking' air out of the toilet room due to outside air turbulence (venturi effect).

ODOUR IS PRESENT OUTSIDE THE TOILET BUT NOT INSIDE THE TOILET ROOM

Some odor from the top of the vent pipe may occur, but it will rarely be detected at ground level.

- Ensure that the vent pipe is installed correctly and that it clears the roof by 60cm.
- If the house is in a very windy area you could be receiving a swirling effect which is pushing the ventilation back down towards the ground. In this case, extend the vent pipe into the clear air flow.
- If the vent is in the wind shadowing of near by trees or buildings then odor may settle back to the ground, extend the vent pipe into clear air flow.
- Check that all joints in the vent pipes are sealed and are not leaking. Also check for cracks in the vent pipe and seal with silicone sealant and duct tape.
- Strong unpleasant odor is a sign the compost pile is not operating in balance. This usually indicates more bulking agent should be applied more frequently or in greater quantities.

ODOUR IS ASSOCIATED WITH THE END PRODUCT

The end product of a Clivus Multrum system should be virtually odorless, similar to that of garden soil.

- Check the vent fan is functioning properly and ensure there is no buildup of liquid in the removal area.
- Shovel material from the removal area back in through the inspection door; add a substantial quantity of wood shavings and mix through with the maintenance tool.
- Increase the quantity of the wood shavings that are regularly added after each use.

FAN IS MAKING LOUD NOISES

- Check fan for obstruction and that it has been correctly installed in the fan housing and is not rattling.
- Lower the transformer voltage to 7 or 8 Volts.
- Fan may be faulty - Visit Clivus Multrum's website for a replacement.

LIQUID IS PRESENT IN THE REMOVAL ACCESS AREA OF COMPOSTING CHAMBER

- Ensure sufficient wood shavings and/or other organic bulking material has been/and are added to the system according to the operation and maintenance instructions above.
- Check the liquid drain is clear from obstruction and has been correctly installed so it slopes away from the chamber.

LARGE LIQUID BUILDUP IS PRESENT IN THE TANK

- This is mostly due to the drain line becoming blocked, it is recommended to check the tank outlet is not blocked by solids, or roots.
- Check that the liquid drain absorption trench is clear and not damaged, or effected by ground water.
- If liquid is non offensive and a clear "tea" colour, drain off excess liquid and dispose of according to local requirements.
- If liquid is more than 10 cm deep, has an offensive odor or is contaminated with solid or scum; this indicates that the lower part of the compost pile has become anaerobic (no oxygen). This situation is best remedied by emptying the tank and then restarting the compost process from step 1 in this manual. Septic tank clean out contractors can readily pump out the tank and dispose of the contents.

COMPOST PROCESS DOES NOT SEEM TO BE WORKING

Note that the top part of the pile will not be composted unless it has had sufficient residence time in the tank.

- It is normal not to notice any composting for the first 6 months.
- Check that a suitable bulking agent is being used.
- Check that disinfectant or antibacterial cleaners are not being used in the pedestal.
- Add a couple of buckets of damp decaying leaf litter found naturally under trees or material from another compost pile will ensure that the correct micro-organisms are present to break down the waste. An Enzyme pack from Clivus Multrum will also help stimulate the process.

COMPOST TOO DRY

- Use maintenance tool to agitate as much of the compost pile as possible and moisten lightly.
- Spray pile with water via inspection door.

COMPOST TOO WET

- Check the vent fan is operating correctly and the vent pipe is clear of obstruction.
- Increase the amount of the wood shavings added.

SEEMS TO BE TOO MUCH TOILET PAPER IS VISIBLE ON TOP OF THE PILE

- Ensure sufficient wood shavings are being added regularly.
- Simply dampen down and agitate the top 100mm or so of compost to mix with the wood shavings.

COMPOSTING PILE MAY BE TOO COLD FOR COMPOSTING

If the composting tank has been correctly sized for the usage and climate, this problem will rectify itself in summer. Clivus Multrum systems operate successfully in very cold climates if properly sized and maintained. The following can increase the rate of decomposition.

- Insulate the tank from a concrete floor.
- Insulate the sides and top from of the tank to retain heat in the compost tank.
- If the tank is in a cellar, duct warm air into the cellar.

Visit ecoflo.com.au for more information:



